

ICX

POWER ASCENDER

User manual

Introduction	A
Product safety & system description	B
Rope	C
Lifting systems & equipment setup	D
Battery care	E
How to use the Ascender	F
Service & maintenance	G
Warranty terms	H
Technical data	I





**HAND-BUILT
IN SWEDEN**

DISCLAIMER

WARNING

Training and experience are required to lower the risk of serious bodily injury or death.

This user's manual provides general information about safe operation and risks associated with the use of the SKYLOTEC ActSafe ICX Power Ascender. It also gives details of maintenance procedures.

Never use the equipment unless you have read and understood this manual and completed a SKYLOTEC approved training in the use of the power Ascender system. SKYLOTEC Nordic AB, our partners and subsidiaries, disclaim any liability for damages, injuries or death resulting from the use of the equipment which is not in compliance with this manual.

This manual may be updated without notice.

For more information about updates and safety warnings, visit www.skylotec.com



Failure to read and follow the instructions within this manual may result in fire, damage to property, personal injury or death.

FOREWORD

Thank you for choosing the SKYLOTEC ActSafe ICX Ascender from SKYLOTEC.

This Ascender has been designed as an ultra-portable and versatile lifting tool for lifting people or equipment in a safe and effective way. It revolutionises working in a vertical environment.

BE AWARE:
A Power Ascender is a hi-tech tool
and should be treated with care.

A

INTRODUCTION

About SKYLOTEC	A.01
About this manual	A.02
Definitions	A.03

A

We are completely committed to our customers and do our utmost to deliver top quality products and service.



A.01 ABOUT SKYLOTEC

SKYLOTEC is a pioneer in developing powered Rope Ascenders and has been delivering high-performance powered equipment since 1997.

SKYLOTEC has a worldwide distribution network of dedicated experts selling our innovative products to a wide variety of users. Our Power Ascenders have been successfully used for installing fireworks at the top of the Eiffel Tower, hostage rescue from pirates at sea and providing essential logistical support in offshore wind turbines.

SKYLOTEC products are redefining the possibilities for work in vertical environments.

A.02 ABOUT THIS MANUAL

This manual gives detailed information on features and safety. However, this manual cannot replace the need for training and experience. The Ascender must only be used by operators who have undergone the SKYLOTEC-approved training.

Safety messages of extra importance are highlighted throughout this manual using the signals 'danger', 'caution', 'note' and 'recommendation'.



DANGER

Not following instructions or training methods may result in **SERIOUS BODILY INJURY** or **DEATH**.



CAUTION

Not following instructions or training methods may result in **BODILY INJURY**, or **DAMAGE TO PROPERTY**.



Note

Important information on the use of the equipment used with the Ascender.



RECOMMENDATION

Instructions and tips on how best to use the Ascender.

A.03 DEFINITIONS

Active/loaded rope

Loaded end of the work-positioning rope system.

Anchor

Attachment point for rope or Ascender.

Ascending

Moving up the rope.

Backup system

A rope system which captures the load in case of primary rope failure. Approved according to backup system requirements with backup device according to EN 12841-A, EN 353-2 or equivalent certified device.

Competent Person

Operator with adequate training, experience and certification.

Descending

Moving down the rope.

Passive/dead rope

Unloaded end of the work-positioning rope system.

Primary rope

Work rope system used with Ascender. Rope must be 11 mm (7/16") and approved according to *EN 1891 A* or be an Equipment Lifting Rope depending on the application.

User/operator

Operator of the Ascender, either by the Throttle or by the Remote Control.

Secondary rope

See 'Backup system'.

SWL

Safe Working Load. The maximum load (as certified by a competent person) that an item of lifting equipment may raise, lower or suspend under particular service conditions.

WLL

Working Load Limit. The maximum load that an item of lifting equipment is designed to raise, lower or suspend.

B

PRODUCT SAFETY & SYSTEM DESCRIPTION

Product safety	B.01
Usage exclusions	B.02
System description	B.03
Rope mechanism	B.04

B

B.01 PRODUCT SAFETY



SKYLOTEC Ascender operators must, before first use, have undergone training in the safe use of the Ascender by either SKYLOTEC or by a SKYLOTEC-approved training partner.

The SKYLOTEC Ascender must be checked before every use by a Competent Person and must undergo a minimum of one inspection per year by SKYLOTEC or a SKYLOTEC-authorized person. More frequent inspections may be required by your national regulations.

B.02 THE ASCENDER **MUST NOT BE USED:**



- » For any purpose other than that for which it has been designed
- » In an explosive environment
- » If modified in any way by anyone other than SKYLOTEC
- » After a free fall from a height of more than 0.5 m (2 ft) or any other severe impact onto a hard surface
- » If subjected to misuse in any way so that parts or components might have been damaged
- » The Ascender system should not be exposed to high impact forces caused by people or loads falling into the system
- » In dark environment without sufficient light for safe operation.
- » In mines or underground quarries.
- » In windspeeds higher than 12 m/s.
- » In weather conditions with risk for lightning.
- » With any Battery other than original Husqvarna 36V Batteries
- » With any other battery charger than an original Husqvarna Battery Charger
- » With a damaged or modified Battery and/or Charger
- » If the operator is unsure of how to use the Ascender safely
- » If you are tired, ill, using prescription medication that prevents you from using machinery, or under the influence of alcohol and/or drugs
- » Without having performed a pre-use check

B

B.03 SYSTEM DESCRIPTION

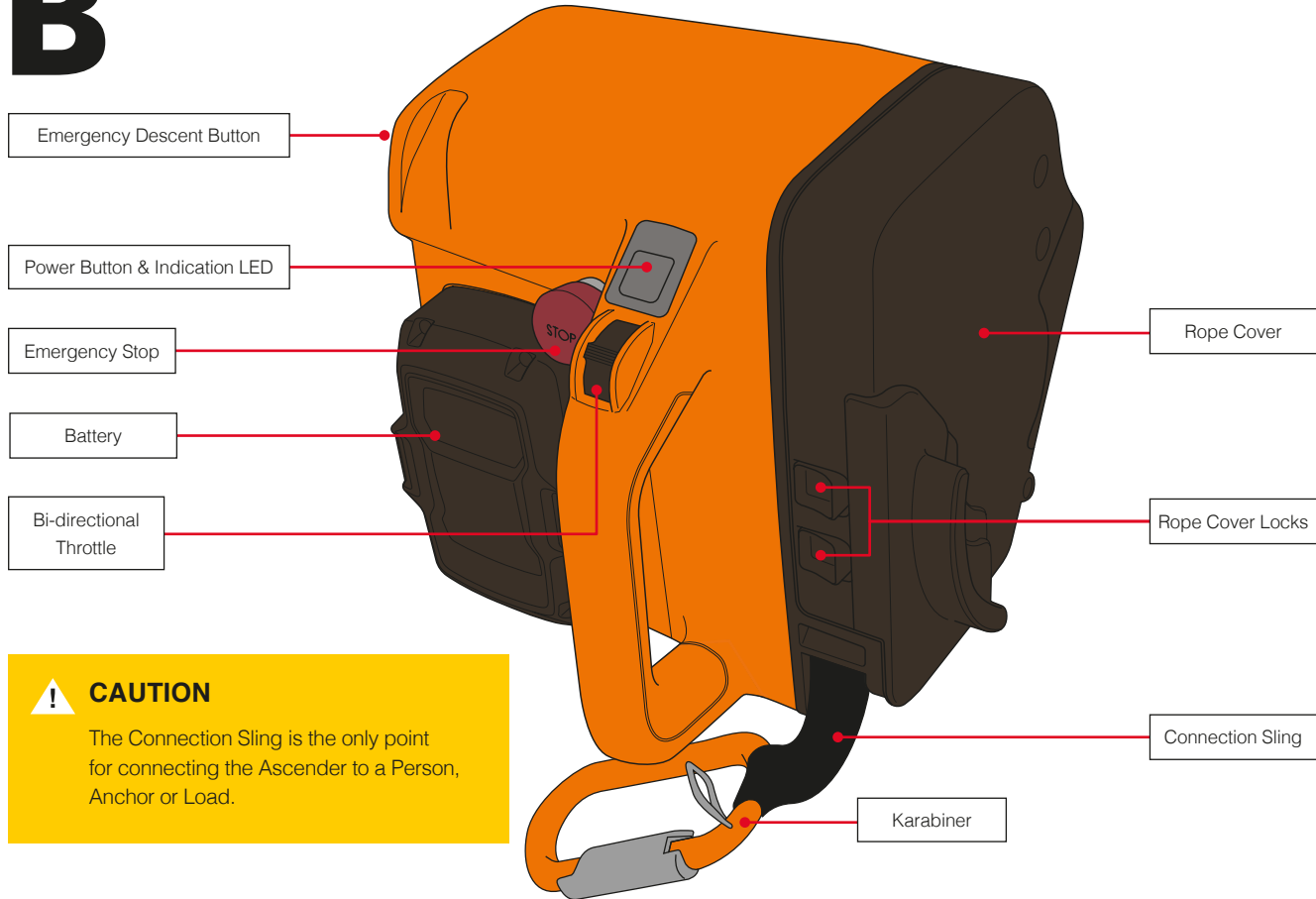

! CAUTION

The Connection Sling is the only point for connecting the Ascender to a Person, Anchor or Load.

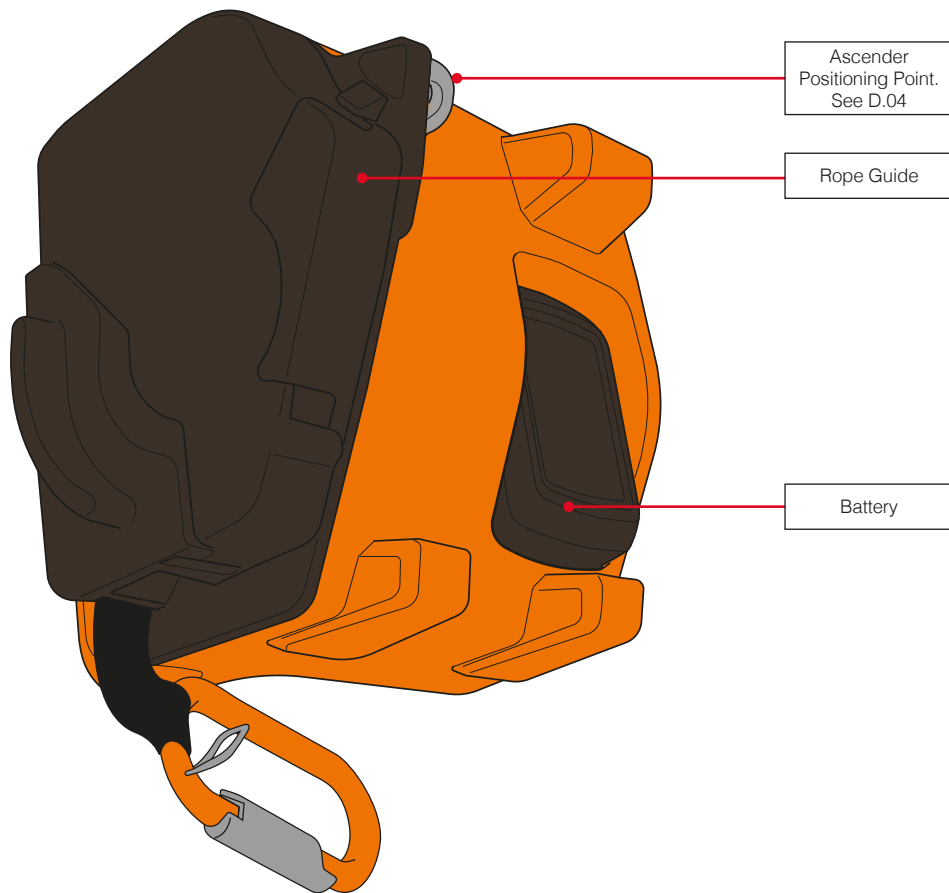

Machine Rating label

The Ascender is supplied with a machine label attached to the housing. This label must not be removed!

The ICX Ascender is approved under the machinery directive 2006/42/EC for lifting both people and equipment with a Working Load (WLL/ SWL) of 185 kg (407 lb).

POA-030	IP55	Serial No: DK1425A1001	SKYLOTEC
Model:	ActiSafe Ascender ICX		
Year:	2023		
Lift:	WLL 185 kg or max. 1 person		
Speed:	0-24 m/min. Max wind speed: 12 m/s		
Rope:	Approved Ø11 mm ropes only		
Contains:	POA 121, ICP, STMG, VBSM001		
	WARNING! READ INSTRUCTIONS BEFORE USE.		CE 1073

B.04 ROPE MECHANISM

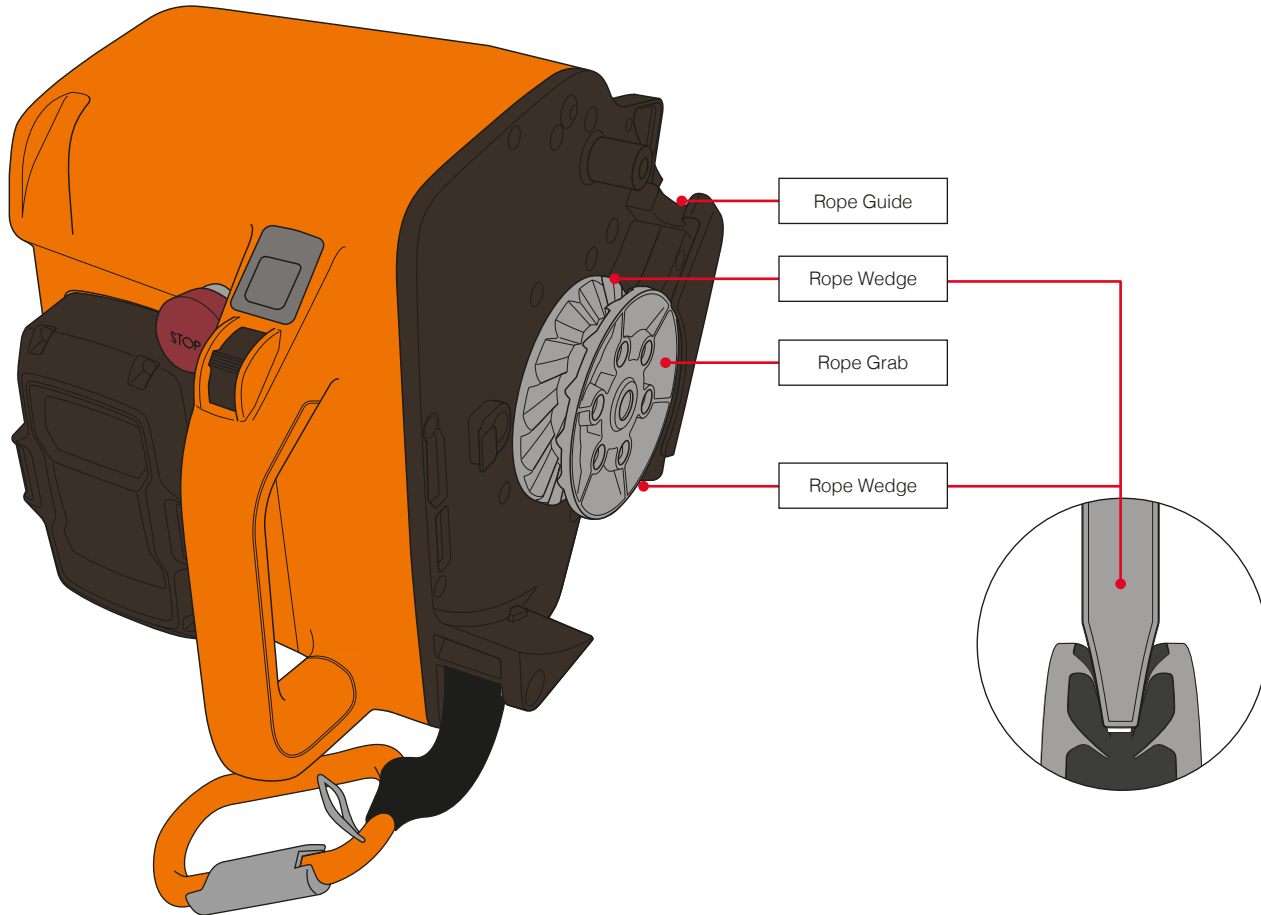

C

ROPE

Rope type
and preparation

C.01

C

C.01 ROPE TYPE AND PREPARATION

The correct choice of rope type depends on whether the Ascender is being used to lift or lower equipment or personnel.

Check with your SKYLOTEC supplier for suitable ropes.

Approved ropes only

SKYLOTEC Power Ascenders may only be used with ropes that have been approved by SKYLOTEC. Approved ropes have gone through a thorough internal test procedure where the combination of rope and Power Ascender are tested under several circumstances. Additional restrictions on use may apply.

Equipment lifting

The ActSafe Equipment Lifting Rope (ELR) is the only approved rope to be used in the equipment lifting system and can be ordered at SKYLOTEC or your SKYLOTEC distributor.

Personnel lifting

The ropes that have been approved for use for lifting personnel are EN 1891-A ropes. For best performance, use:

SKYLOTEC PLR - semi static 11mm
SKYLOTEC R-080 11mm

For an updated list of approved ropes, please visit the SKYLOTEC website at www.skylotec.com.

Softer ropes are unsuitable for the use in SKYLOTEC Ascenders. Softer ropes should be avoided because they deform under load, grip is poor and can potentially jam the Rope Grab system.

Pre-Soaking (applies only to Polyamid ropes)

It is recommended that only pre-soaked ropes are used with SKYLOTEC Ascenders. New ropes should be put in cold water <40°C (104°F) for 24 hours and dried slowly afterwards.

This will make ropes more suitable for use in SKYLOTEC Ascenders for two reasons:

1. Rope density

Pre-soaking makes ropes denser. The fibres will absorb the water and will shrink when drying.

The result is that all fibres become more densely aligned and the sheath sits tighter around the core of the rope. This will make the rope more solid and will consequently result in less mantle slippage and deformation and thereby lead to better grip in the Ascender.

2. Oil dissolution

During the production process some oil is added to the rope fibres in order to reduce the friction between the individual fibres. When soaking the rope in cold water some surface oil in the sheath of the rope will dissolve. This will contribute further to a better grip. Do not soak ropes in warm water, this will lead to greater dissolution of

oil, which will have a negative impact on the rope properties.



CAUTION

Always make sure that the rope is in good condition.



RECOMMENDATION

A new rope will get an increased service life if it is soaked in cold water before the first use.

Avoid getting sand or dirt onto/ into the ropes since it will wear the Rope Grab and Rope Guide. Use a rope mat, rope bag or similar.



D

GENERAL SAFETY GUIDELINES AND LIFTING SYSTEMS

General safety guidelines	D.01
Declaration of Conformity	D.02
Personnel lifting	D.03
Personnel safety checklist	D.04
Personnel lifting setup	D.05
Equipment, material and tool lifting	D.06
Basic lifting safety rules	D.07
Lifting setup	D.08
SKYLOTEC Training Network	D.09

D

D.01 GENERAL SAFETY GUIDELINES

The ICX Ascender system requirements are described in the following pages.



DANGER

DO NOT USE the Ascender if you are tired, ill, using prescription medication that prevents you from using machinery, or under the influence of alcohol and/or drugs.



CAUTION

DO NOT hold the loaded rope when ascending as there is a risk of pinching.

- » Operate the Ascender according to the advice contained within this user manual and pre-planned work instructions (lift plan, access plan)
- » Only trained and competent operators should operate the ICX Ascender and its ancillary equipment
- » Plan and evaluate your work carefully. A rescue plan should be in place. The rescue plan may involve lowering of the operator by a supervisor using the remote control.
- » Plan for appropriate supervision of work
- » Perform a toolbox talk before starting the work
- » Use only approved and inspected equipment. This goes for the Ascender, PPE and/or lifting equipment
- » Inspection of equipment must be carried out in accordance with local regulations. The Ascender should undergo a documented inspection at least once every year
- » Pre-use check of the Ascender should be carried out in accordance with the inspection guidance provided (see F.11)
- » Use PPE (Personal Protective Equipment) such as helmet, gloves and protective eye wear when required
- » Keep your hands, hair and clothing away from moving parts
- » Keep a constant eye on the Rope Guide to ensure that the rope is running smoothly through the rope mechanism
- » Avoiding long exposure to uncomfortable work positions and procedures to reduce risk of ergonomic related injuries. Use relevant PPE for protection and to enhance ergonomics.

D.02 DECLARATION OF CONFORMITY

EC DECLARATION OF CONFORMITY	
Machinery Directive 2006/42/EC	
Manufacturer: Skylotec Nordic AB, Sagbäcksvägen 13, 437 31 Lindome, Sweden	
It is hereby certified that the following product	is made according to:
Description, ID/mark, type: ActSafe Ascender ICX	DIRECTIVE 2006/42/EC (MD) DIRECTIVE 2014/53/EU (RED)
Notified body: DANCERT Grogersensvej 1, 2630 Taastrup Notified Body No 1073	Harmonised standards: EN 1808:2015* EN 14492-2:2019* ETSI EN 301 489-1 v2.2.3 ETSI EN 301 489-17 V3.2.3 EN IEC 61000-6-2:2019 EN IEC 61000-6-8:2020 EN 60204-1:2018* EN 62745:2017* EN 12100:2010 EN ISO 13849-1
EC type-examination certificate: DAN-23-MD-0502	
<small>*Relevant parts of harmonised standards</small>	
Name Jörgen Hellman	
Job title Managing Director	
Signature 	
Place and Date Lindome 2023-10-11	
 DANCERT TEKNOLOGISK INSTITUT	 HAND-BUILT IN SWEDEN



SKYLOTEC Nordic AB
Sagbäcksvägen 13
437 31 Lindome
Sweden
T: +46 31 65 56 60
E: info@skylotec.se

D.03 PERSONNEL LIFTING

The ICX Ascender, when used to lift people, must be used with personal protective equipment approved for work at height, rope access and/or rope rescue.

Basic requirements:

The rope system must consist of a primary work rope system and a secondary backup system.

For personnel lifting the primary rope used in the Ascender must be approved to *EN1891 A* and have a diameter of 11 mm (7/16") and the backup system must fulfill the respective requirements.

Each system must be connected to an anchor that meets the appropriate personal lifting requirements. A competent person shall judge if the anchor points are sufficient and safe to use.



DANGER

DO NOT USE the Ascender without a backup system.

D.04 PERSONNEL SAFETY CHECKLIST

Before use make sure that you:

- ✓ Check all equipment and components
- ✓ Wear appropriate clothing and tie back any loose clothing or hair
- ✓ Do not swing excessively while descending/ascending
- ✓ Only use the Ascender if you have successfully completed SKYLOTEC training
- ✓ Have an emergency plan in place



Note

For personal lifting the supplied SKYLOTEC Karabiner may be replaced with any other *EN362* connector (or any other approved lockable connector, Non EU countries). All other parts of the Ascender shall only be replaced with original SKYLOTEC parts by an SKYLOTEC-approved service engineer.

2-Rope system

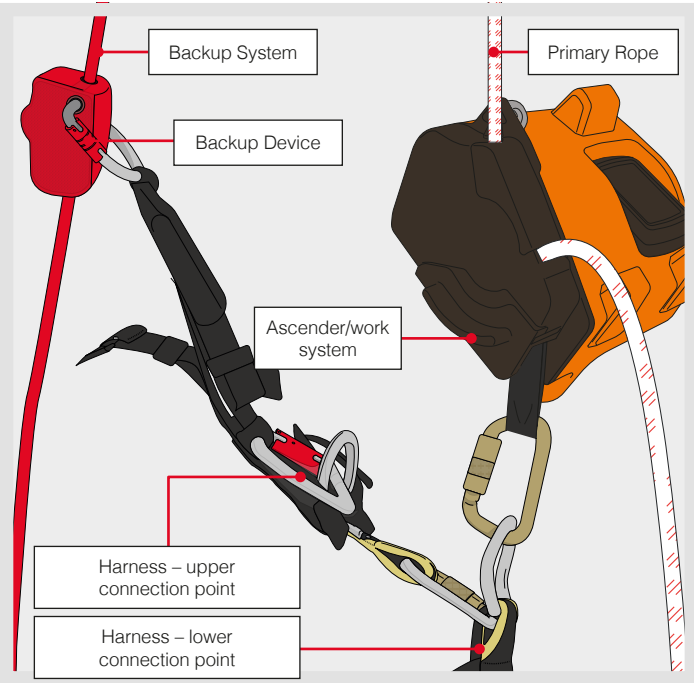
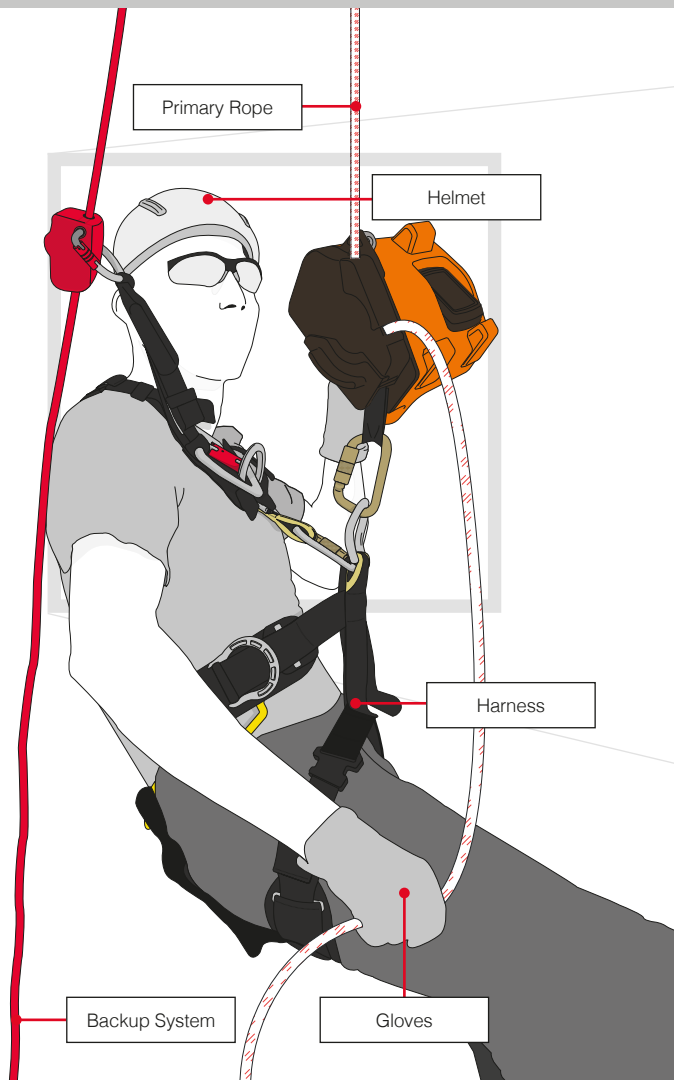

RECOMMENDATION

A work seat is recommended for comfort and safety.



DANGER

When driving the Ascender the operator must wear a helmet and a fall arrest harness that is also suitable for work-positioning/rope access.

D.05 PERSONNEL LIFTING SETUP

Displayed here are the four standard personnel lifting setups that are suitable for use with the ICX Ascender. They are shown for illustration purposes only. For further guidance, please contact your local SKYLOTEC supplier or SKYLOTEC directly.

DANGER

Avoid driving the ascender into the carabiner on the rope, a stopper knot or solid objects. This can damage the rope and or the Ascender.

CAUTION

Always hold the unloaded rope when the Ascender is rigged to an anchor.

Do not put load on the free end of the rope coming out below the Ascender. This can damage the rope cover.

RECOMMENDATION

Use different color ropes for different rope systems to improve safety.

Active / Running Basic setup

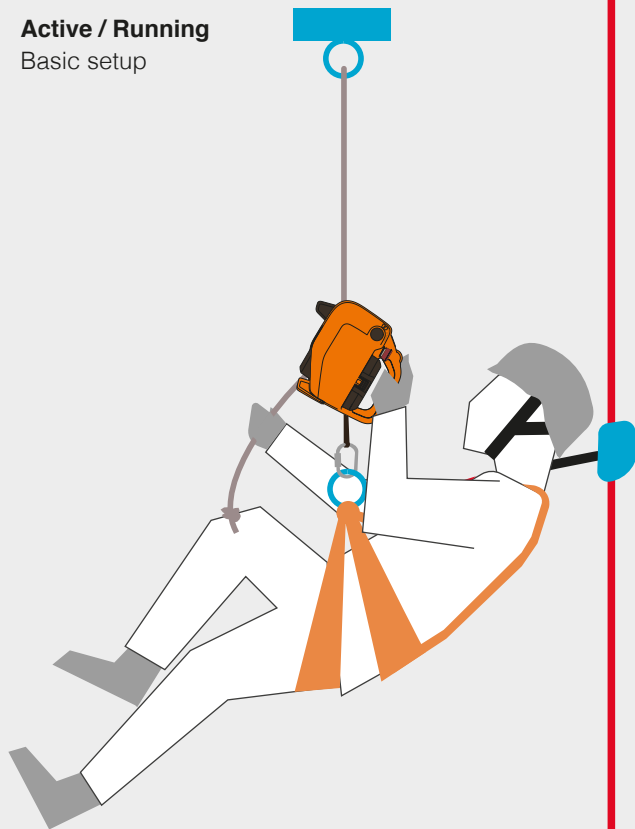

Top Rigged Basic setup

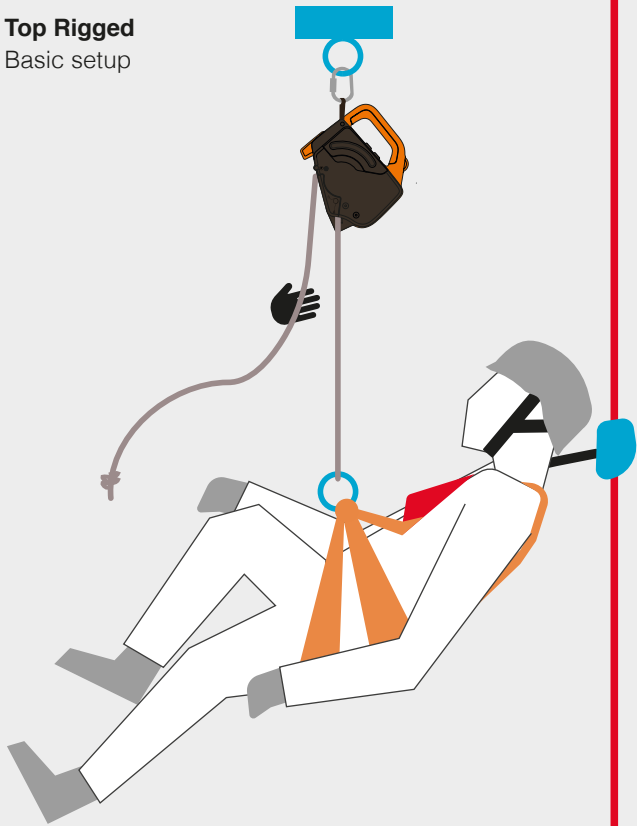

Bottom Rigged Basic Setup

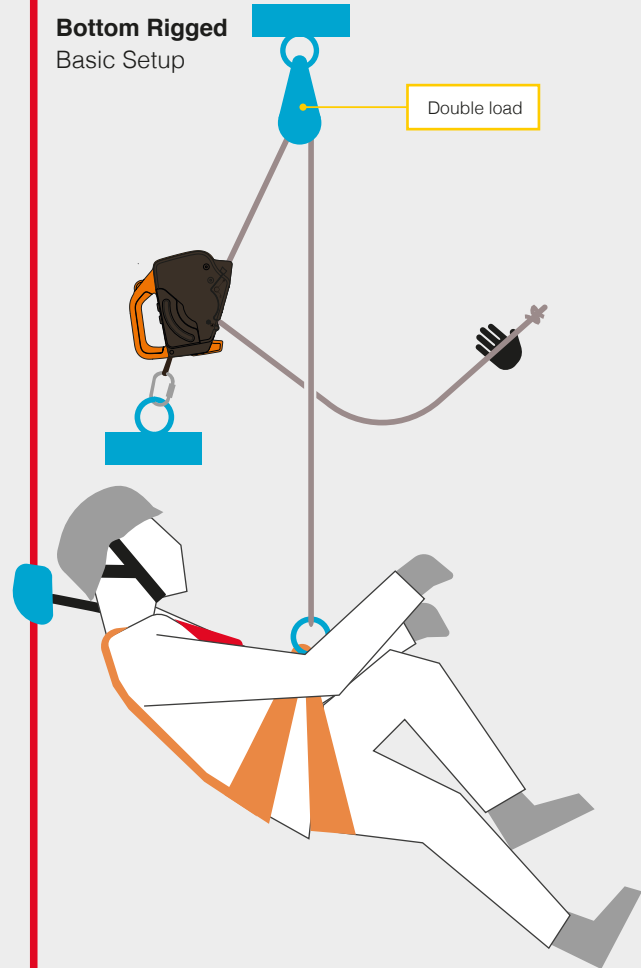

Pulley

Expert use only

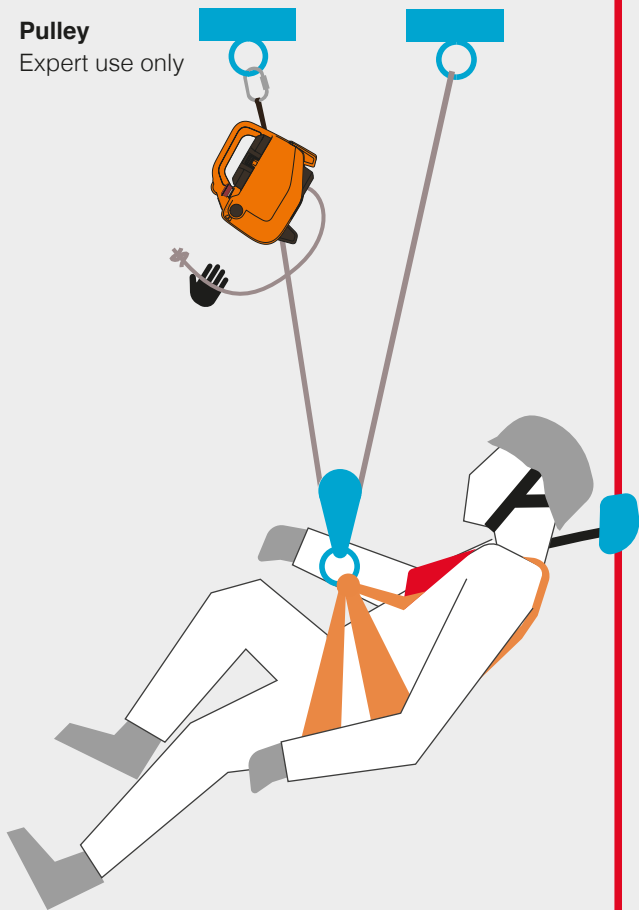

Pulley

Expert use only.
ICX pulley rigging
on a single anchor

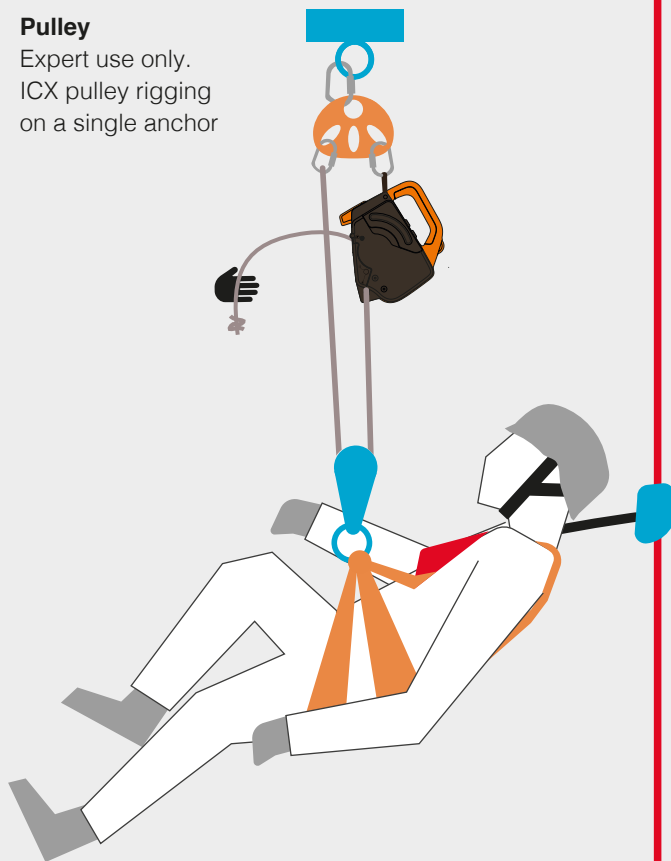

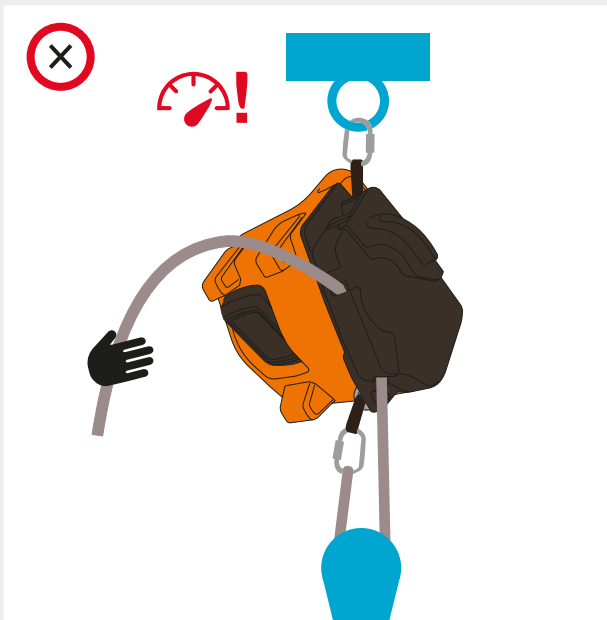

! DANGER

Do not use the Ascender Positioning Point as an anchor extension for making pulley systems as this would risk double-loading the frame plate, Sling Bolt and Connection Sling with the risk of having an insufficient factor of safety on the Connection Sling.

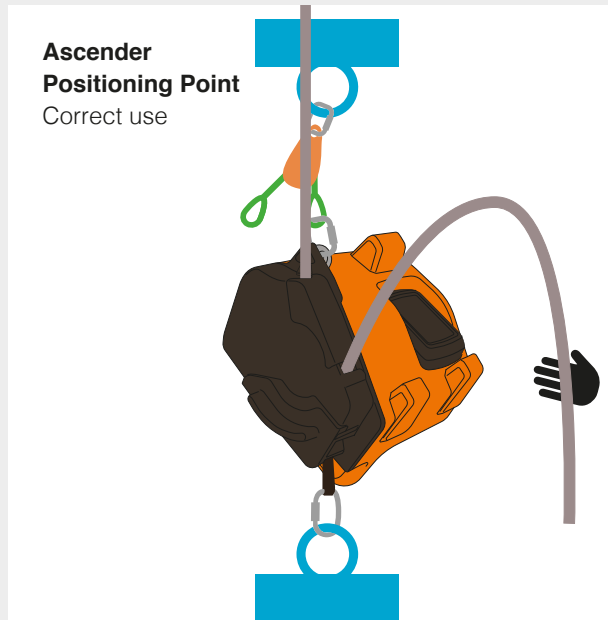

✓ Note

This setup can be used in cases where the Ascender is rigged to an anchor and the operator wishes to avoid the Ascender dropping when the rope becomes unloaded. However, the Ascender must be allowed to rotate freely while suspended.

D.06 EQUIPMENT, MATERIAL AND TOOL LIFTING

The ICX Ascender is, in combination with the ActSafe Equipment Lifting Rope (ELR), approved under the Machinery Directive as an equipment lifting system provided that all other equipment used also meets lifting requirements. (Rated capacity of 2 times the total load actually suspended.)

The lifting system must be connected to an appropriate anchor that meets requirements for load lifting anchors (a competent person shall judge if the anchor is sufficient and safe to use).

CAUTION

Weather conditions should be stable and favourable to not affect the safety of personnel and/or lifting operation. Wind speeds should be less than 12 m/s (39 ft/s) and the surface area of the load should be considered as this will affect the lifting operation.

RECOMMENDATION

Lifting operations are ideally performed with a 3 person team. A lifting supervisor, a slinger for attaching loads and an Ascender operator.

Note

For equipment lifting the supplied SKYLOTEC Karabiner may be replaced with any approved positive locking shackle with a minimum WLL of 0.5 t. All other parts of the Ascender shall only be replaced with original SKYLOTEC parts by an SKYLOTEC-approved service engineer.

D.07 BASIC LIFTING SAFETY RULES



Always keep an eye on the load while lifting



Avoid excessive inching
(i.e. short pulses of the motor)



Do not exceed the Safe Working Load (SWL)
of the entire lifting system



Stay clear of the load whilst lifting



Do not try to lift fixed or obstructed loads



Do not stand under the suspended load



Do not side-pull loads



Use hand signal or radio communications
during lifting operation

D.08 LIFTING SETUP

Displayed here are the four standard lifting setups that are suitable for use with the ICX Ascender. They are shown for illustration purposes only. For specific guidance, please contact SKYLOTEC or an SKYLOTEC distributor.

CAUTION

DO NOT let the rope become obstructed or blocked when going into the Ascender.

Note

The Ascender operator should, at all times, control the unloaded rope during lifting operations to avoid the rope from twisting when running into the Ascender.

Top-rigged
Basic setup

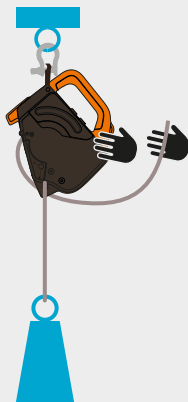

Bottom-rigged
Basic setup



Running Ascender
Expert use only

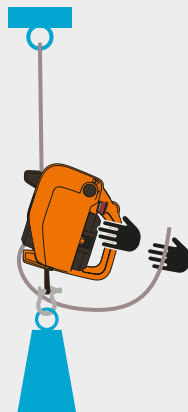

Pulley
Expert use only

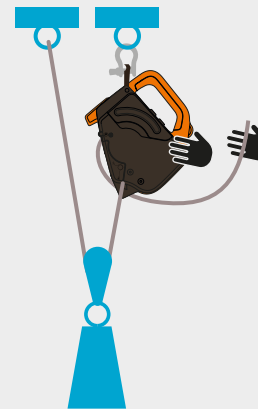

D.09 SKYLOTEC TRAINING NETWORK

The SKYLOTEC ActSafe Power Ascenders are extremely versatile high-tech lifting tools that are designed for use in demanding environments.

Working with these Ascenders requires experience, competence and a thorough understanding of its possibilities and limitations. Therefore, training is essential.

We offer the SKYLOTEC training programme through our network of highly competent instructors, who are specialists in their respective field of operation and will help you get the most out of your SKYLOTEC Ascender.

SKYLOTEC training is available for different skill levels and fields of application and can be provided on site or in training centres all around the world. Get in touch with your local distributor or with SKYLOTEC to learn more about training possibilities.

Operator lifting

SKYLOTEC training is developed to offer a modular system with the aim to meet the level and needs of the customer. At the end of each training course the operator will be able to use the Ascender System in a safe and appropriate manner. For bespoke training solutions contact SKYLOTEC or the SKYLOTEC Vertical Rescue College.

SKYLOTEC PERSONAL LIFTING

Experience: Hold a valid work at height certificate.

Duration: Minimum 2 days

This is a modular training for future Ascender operators to give them the knowledge and skills for using Ascenders for designated tasks. The training outline and duration will vary upon the skill level of the participants.

Equipment lifting

SKYLOTEC EQUIPMENT LIFTING

Experience: Delegate should have completed training for working at height and must meet statutory training requirements for the lifting of loads.

Duration: 5 hours

This training is intended for specialist workers who will use the Ascender as their everyday equipment-lifting tool.

E

BATTERY CARE

The Ascender Battery	E.01
Performance	E.02
Battery charging	E.03
Battery Status Indicator	E.04
Descending on a full Battery	E.05
Connecting and disconnecting the Battery from the Ascender	E.06
Storage and transportation	E.07
Battery lifetime and disposal	E.08

E

E.01 THE ASCENDER BATTERY

SKYLOTEC Ascenders use Husqvarna 36V lithium-based batteries with a very high energy density and are therefore very compact, light-weight and extremely powerful. Due to the high energy the batteries contain, it is of utmost importance that they are treated with care and that the user has read the following section with attention. This is for your own safety, but also for optimal Battery life and performance. Please consult the Husqvarna battery user manual for further information.

SKYLOTEC recommends users to follow the Battery care guidelines below for optimal lifetime and performance:

- ✔ Battery can stay connected to ICX during transport or short term storage (1 week). For longer storage, disconnect the Battery and do a maintenance charge every 3 months
- ✔ Always charge batteries as soon as possible after use
- ✔ Disconnect batteries from the charger after charging
- ✔ Always store batteries fully charged
- ✔ Store batteries between 5°C (41°F) and 25°C (77°F)



DANGER

Not following instructions may result in **DAMAGE TO PROPERTY, SERIOUS BODILY INJURY OR DEATH.**



Note

Charge Battery before first use. The battery is only 30% charged when delivered.

General guidelines and warnings

- » Battery charging must be conducted in a safe area away from combustible or other flammable materials
- » Do not charge the Battery unattended
- » When hot, allow the Battery to cool down to room temperature before charging
- » Immediately remove the Battery or charger from service:
 - If there is visible damage to the housing, cables or connectors, including the Battery Connectors on the Ascender
 - If the Battery has been dropped as there may be internal damage that isn't visible
 - If the Battery emits an unusual smell, feels hot, produces smoke, changes shape, or appears abnormal in any other way. Since a delayed

- reaction can occur, observe the Battery for a minimum of 15 minutes in a safe area and away from any combustible material
- » Only use the original Battery Charger
 - » Do not disassemble or modify the Battery in any way. The Battery contains safety and protection electronics, which, if damaged, may cause the Battery to generate heat, explode or ignite
 - » Do not expose the Battery to water

Follow Battery care instructions to enable a long battery life.



DANGER

Do not use any other battery chargers as they can damage the Battery and may create toxic gases which cause a fire.

E.02 PERFORMANCE

Ascender Performance

When using the Battery, the Ascender has a lifting capacity of up to 185 kg (407 lb) or up to a distance of 491m (1610 ft). The distance is dependent on the lifted load and temperature of the environment. The optimal operating temperature range is between 5°C (41°F) and 35°C (95°F). The maximum temperature range is from -10°C (14°F) to 40°C (104°F); the Battery performance will be greatly affected in these extreme conditions. See chart opposite for detailed information.

Battery Capacity

Low temperatures:

The capacity of the Battery is affected at temperatures below 5°C (41°F) which will result in an initial loss of lifting performance (speed) and will affect the lifting distance. The Battery will behave as if it wasn't fully charged but will warm itself during the first minutes of operation. Lifting performance is regained but there will be a loss in distance depending on the temperature of the environment.

High temperatures:

Battery performance will be affected by temperatures over 40°C (104°F) which will result in high internal battery temperatures and therefore in a reduced lifting distance. In case of the Battery overheating the BMS is designed to shut the Battery off until the Battery has cooled to operating temperature.

RECOMMENDATION

In cold environments, maintain optimal Battery temperature and performance by keeping the Battery in the transportation box as long as possible.

Note

Initial lift speed capacity will be limited with a cold Battery. It is only possible to ascend at lower speeds until the Battery warms up and normal performance can be expected.

There is a difference in performance between old and new Batteries, all figures are based on new Batteries.

Lifting distances with battery powered ICX with 100 kg (220 lb), 150 kg (330 lb) and 185 kg (407 lb) with different batteries at temperature 20°C (68°F).

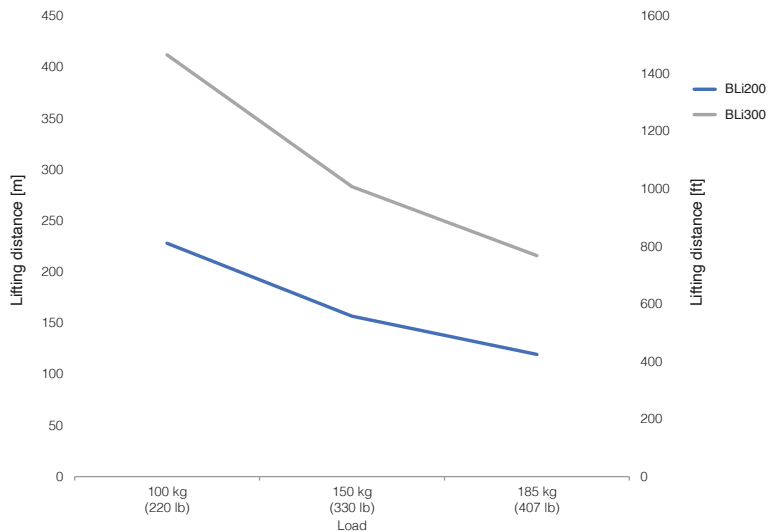

Note

All values on this page apply to operating temperatures. Ascenders and especially batteries should be stored between 5°C (1°F) and 25°C (77°F) for optimal performance and service life. **For more info see section E.08.**

E.03 BATTERY CHARGING

The ICX Battery can be charged at any charging level, no 'memory effect' will occur. It is important that the batteries are charged with an original Charger.

The charging time is dependent on the charging level of the Battery. The maximum charging time is 80 minutes. During charging the current charging level is displayed on the Battery LEDs and the Battery is fully charged when all 4 LEDs are lit continuously.

1. Connect the Charger to mains supply.
2. Connect Battery to charger.
3. Constant charging controlled by BMS. The Battery is full when all 4 Battery LEDs are continuously lit.
4. Disconnect Battery from charger.
5. Disconnect Charger from main supply.

CAUTION

Inspect before charging the Battery, the Charger Cables and the insulation on the socket to avoid risk of electric shock.

Note

Charging must be carried out in a dry area.

Disconnect the charger from the power source when not in use.

DANGER

Do not touch the Battery Charger during charging with wet hands or disconnect the plug by pulling the cord.

E.04 BATTERY STATUS INDICATOR

The Battery Status Indicator is positioned at the top of the Battery and can be activated by pushing the button next to the LEDs. The Battery Indicator has 4 LEDs each representing 25% charge.

LED indicator Battery status (state of charge)	
4 LED lights are on	The battery is 76% - 100% charged.
3 LED lights are on	The battery is 51% - 75% charged.
2 LED lights are on	The battery is 26% - 50% charged.
1 LED light is on	The battery is 6% - 25% charged.
1 LED light is flashing	The battery is 0% - 5% charged

E.05 DESCENDING ON A FULL BATTERY

When starting your workday with a traditional ground up ascent the feature of regenerating energy while descending to charge the battery gives the user some extra battery range. If starting top down with a fully charged battery the device will be heated up during descend. This is ok but the range going down is limited as the device will eventually be overheated and stop. If this happens it will stop and cannot continue until it has cooled down.

- Plan your work so that starting descents on a full battery is avoided.

- Any distance that has been ascended can always safely be descended on the same battery.
- Only use Emergency descent as an emergency measure, using emergency descent wears the brake disc and will lead to higher maintenance costs.
- The battery doesn't have to be fully charged if you know that the next day will start with top down work, the charging process can be aborted at any given point at a charging level suitable for next job.

CAUTION

DO NOT descend on a fully charged Battery as a standard procedure.

CAUTION

Emergency descend must not be used more than 100 meters of continuous descending due to heat up of the device.

E.06 CONNECTING AND DISCONNECTING THE BATTERY FROM THE ASCENDER

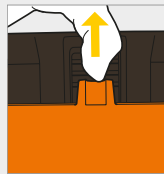

Disconnecting the Battery

Release the Battery by squeezing the 2 buttons and pulling outwards.

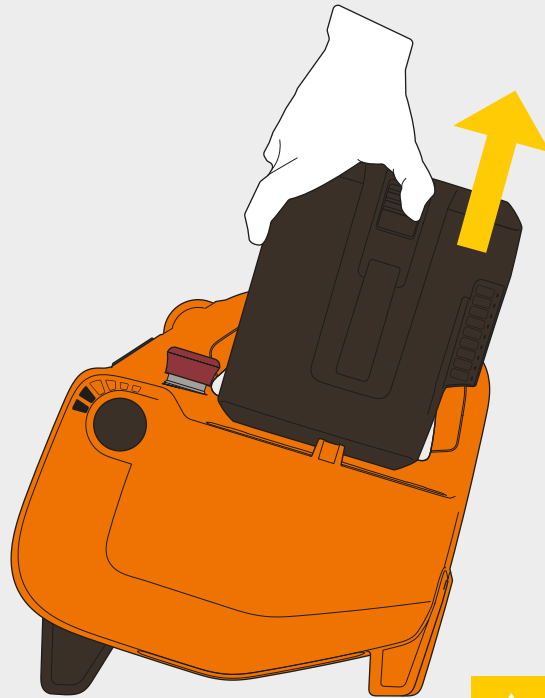

Connecting the Battery:

Slide the Battery into the Ascender and ensure that the Battery is locked.

The Battery Lock must snap into its position (2 clicks).

! CAUTION

If removing the battery at height, take precautions to prevent dropping the battery.

E.07 STORAGE AND TRANSPORTATION

- » All lithium-ion batteries degenerate over time, even if they are properly stored. Disconnect the Battery when stored for longer periods with 100% charge
- » If storing a Battery for a long time, recharge the Battery every third month
- » Ideally store the Battery at room temperature of 5°C (41°F) to 25°C (77°F). Storing at higher temperatures will result in a loss of performance and a shortened service life
- » Do not store the Batteries at temperatures higher than 60°C (140°F), as this will cause permanent damage to the Battery and possibly result in fire
- » The user assumes total responsibility for all risks associated with lithium-based battery technology
- » Batteries stored in temperatures below 5°C (41°F) will show severe

loss in performance during use, but will not sustain any permanent damage because of the storage in low temperatures

- » Product warranty is limited to original defects in material and workmanship. The Warranty does not cover collateral damage

CAUTION

Storing an empty Battery or a Battery with low charge level can damage the Battery irreversibly (deep discharging).

Note

Batteries are fully regulated as Dangerous Goods (Class 9 UN3480 Lithium Ion Batteries) and must be handled and shipped accordingly. A defective Battery must not be shipped.

E.08 BATTERY LIFETIME AND DISPOSAL

The Battery lifetime is dependent on a lot of different factors such as: intensity of use, charging cycles, storage temperature etc. For this reason it is very difficult to give a specific indication on the service life of a Battery, see also E.01. The Battery Management System or BMS constantly monitors the condition of all the cells in the Battery. For user safety, the Battery is designed to shut down automatically if the cells become too worn out. In this situation the Battery can no longer be used. Do not incinerate or dispose of the Battery in your normal waste system. Dispose of the Battery at a recycling centre as per the appropriate regulations.



F

HOW TO USE THE ASCENDER

Connecting the rope	F.01
Ascender activation	F.02
Ascent and descent	F.03
Emergency descent	F.04
Emergency Stop	F.05
Twisted rope and rotation	F.06
Remote Control	F.07
Remote Control operation	F.08
Transportation	F.09
Storage	F.10
Checklist before use	F.11

F.01 CONNECTING THE ROPE

The Ascender must be switched off while loading the rope.

Push the Emergency Stop to ensure that the Ascender is switched off.



1. Open the Rope Cover by pulling on the Rope Cover and pushing both of the rope lock covers to the right.

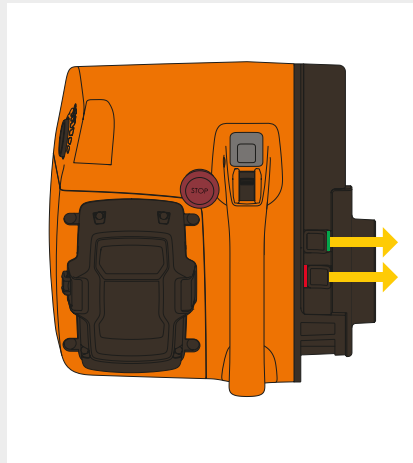

2. Feed the rope counter-clockwise through the slot in the Rope Guide and around the Rope Grab.



3. Continue feeding the rope in a counter-clockwise direction.

! CAUTION

Always check that the rope is attached correctly and has a stop-knot on the other end of the rope. Failure to attach the rope correctly could result in damage to the rope and loss of grip on the rope.

Load the rope when the Emergency Stop of the Ascender is activated to avoid accidental activation by the Remote Control.

Ensure that the Rope Cover is locked into position.

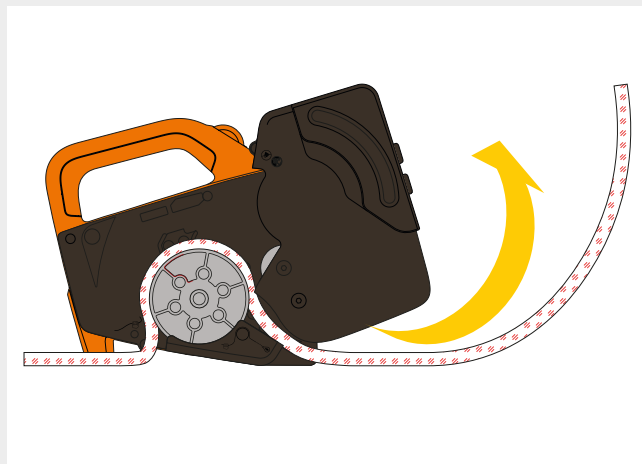

4. Feed the rope through the slot in the Rope Guide. Tighten the rope a little. The rope will be pulled into the Rope Grab and the Rope Cover can be closed more easily.

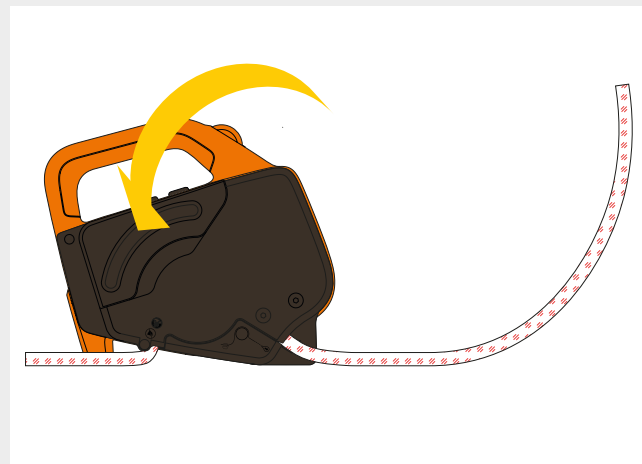

5. Close the Rope Cover and ensure it is locked. Both of the rope cover locks should snap into its position. A distinct 'click' should be heard. Never attempt to close the Rope Cover with force.

F.02 ASCENDER ACTIVATION

To activate the Ascender check that the Emergency Stop button is pulled out. Switch the Ascender on by pushing the Power Button. The green indicator LED starts blinking and the Ascender performs a self-test, which will take a few seconds.

The Ascender is ready to use once the green LED indicator is lit continuously.

The Ascender will remain on for 4 hours after its last operation.

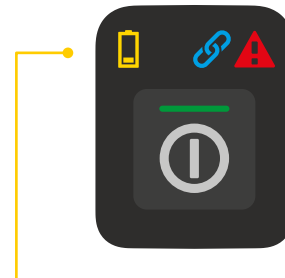

BLINKING LIGHTS The Ascender is starting up and performing self-test



GREEN The Ascender is on and ready to use



BLUE The Ascender is connected to the Remote Control



BLINKING YELLOW Battery Power Low - less than 10% power left



BLINKING RED / RED A fault has been detected and the Ascender will not operate. Close the rope cover. If the red light remains lit, check trouble shooting guide.



Note

The Ascender has no standby function, the Ascender can only be switched on by pushing the Power Button.

F.03 ASCENT & DESCENT

To move the Ascender up the rope, push the thumb wheel throttle up. When released the Throttle will return to the neutral position and the Ascender will stop moving.

To move down the rope, pull the thumb wheel throttle down in the opposite direction.

Adjust the speed according to the circumstances, be aware and use common sense.

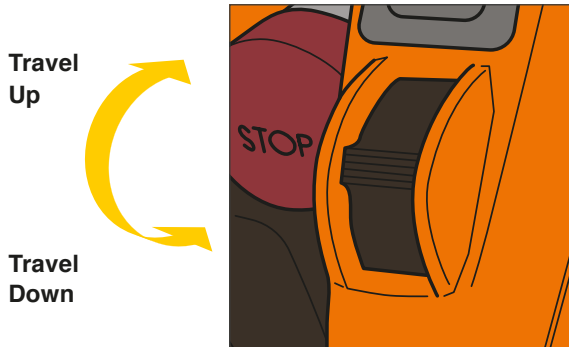

! CAUTION

Do not hold on to the loaded rope just above the Ascender, as there is a risk of injury.

i RECOMMENDATION

Stand straight beneath the Anchor Point in order to avoid a pendulum movement when starting off the ground.

✓ Note

Make sure that the unloaded rope runs in a controlled manner out of the Ascender. Take special care feeding the loose rope into the Ascender when descending.

The in-built ICX electronic monitoring system will prevent lifting loads over 185 kg (407 lb).

DO NOT descend on a fully charged Battery as a standard procedure. **See section E.06.**

F.04 EMERGENCY DESCENT

The emergency descent is ONLY to be used to get down in a safe and controlled manner in case of an Ascender failure.

The Emergency Descent Button enables a mechanical release of the Ascender brake.

- Only use Emergency descent as an emergency measure, using emergency descent wears the brake disc and will lead to higher maintenance costs.
- The emergency descent speed is limited to provide a controlled descent at a constant speed.
- Emergency descent shall not be practiced over long distances for training purposes, one or two meters at low speed is enough to understand how it works.

Emergency descent procedure:

1. Hold the dead rope in one hand.
2. Descend by gently pushing the emergency descent button.
3. Stop the descent by releasing pressure on the button.

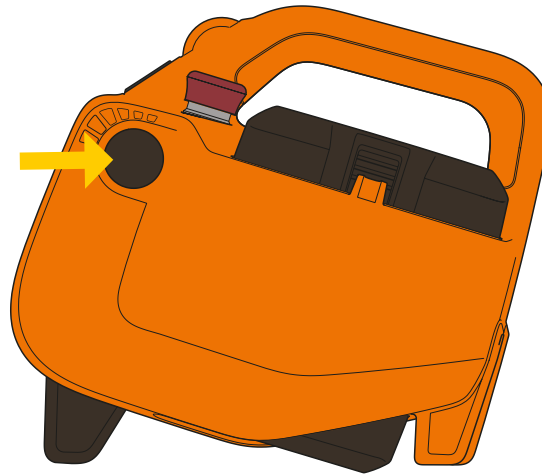



CAUTION

An emergency descent can result in serious damage to the Ascender. Only use the emergency descent in case of an emergency.



CAUTION

Only use the emergency descent in case of an emergency.



RECOMMENDATION

Always try to restart the Ascender first before using the emergency descent method.



NOTE

In case the Ascender is stopping during ascent because of an empty Battery, it is still possible to descend whilst using the Throttle.

F.05 EMERGENCY STOP

1. Press the Emergency Stop to immediately turn the Ascender off.
2. Reset the Emergency Stop by twisting the button outwards.



✓ Note

The Indication LED will turn red for a short moment and then switch off when the Power Button is pushed while the Emergency Stop is activated. The Ascender cannot be activated as long as the Emergency Stop is pushed in.

F.06 TWISTED ROPE AND ROTATION



Ensure, especially when descending, that the rope runs untwisted into the Ascender. Twisted ropes caught into the Rope Guide can cause a rope jam and can, in rare cases, result in rope damage.

i RECOMMENDATION

When descending, hold the rope entering the Ascender to prevent it from running twisted into the Ascender.

! CAUTION

When descending, make sure the rope is fed neatly into the Rope Grab so that there are no kinks or twists in the rope. Take special care when using long ropes to prevent twists or kinks. Good rope management is ESSENTIAL.

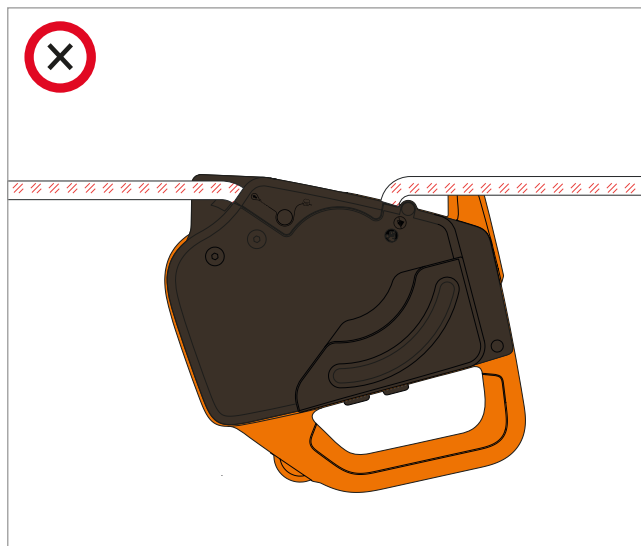

The dead rope must never be loaded (in order to avoid side loading on the Rope Guide). Do not build tramways using the primary rope as shown in the picture.

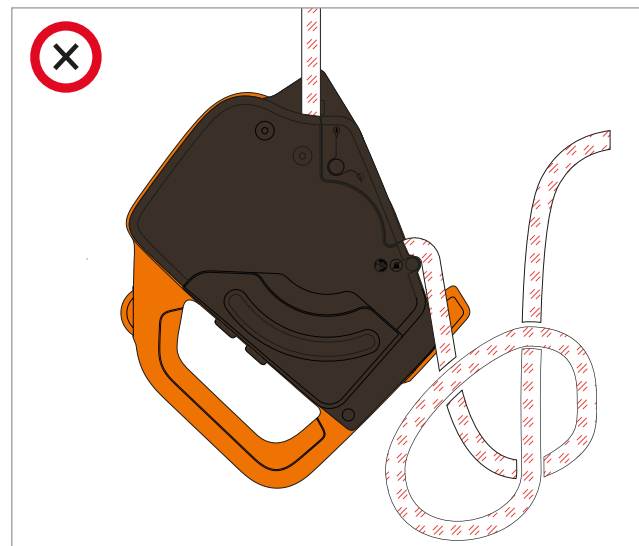

Stop immediately when a rope twist is observed, untwist and organise the rope before continuing.

F.07 REMOTE CONTROL

The Remote Control can be used for a multitude of applications for both personnel and equipment lifting.



50m (164ft)

The ICX Ascender can be operated by a Remote Control to a distance of up to 50m (164ft) in direct line of sight.

The Remote Control will interrupt the throttle control on the Ascender when used. The operator of the Ascender can take back control by using the throttle.

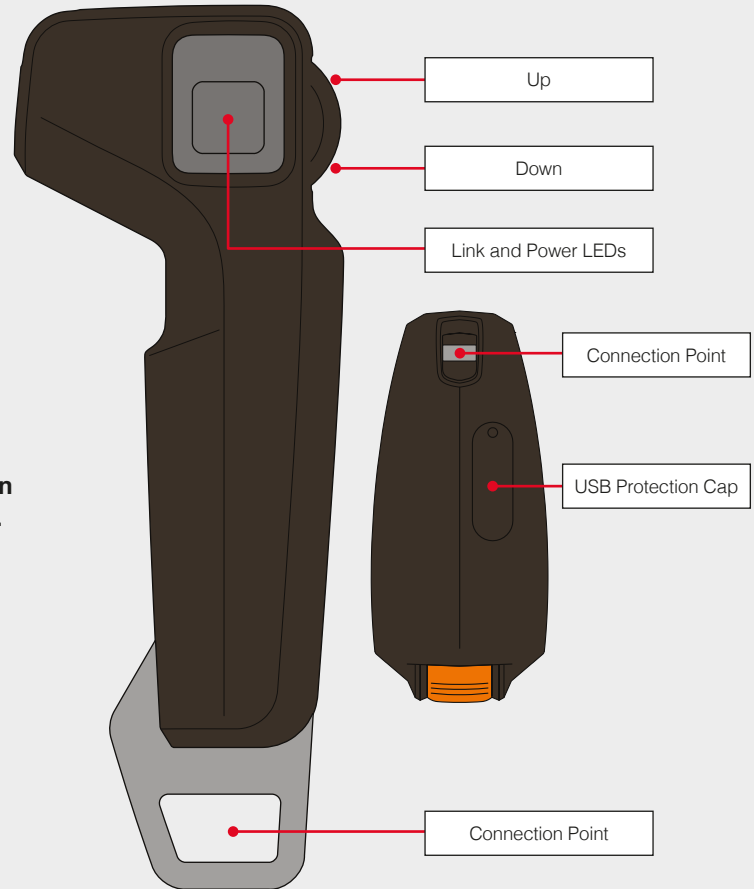

F.08 REMOTE CONTROL OPERATION

1. Activation and connection



Activate the Remote Control by pushing the Power Button.



The green 'POWER' LED will show and the blue 'LINK' LED will start to blink for a few seconds whilst a connection is established with the Ascender.



Once connected, the blue 'LINK' LED on the Remote Control will be lit continuously.

2. Take control of the Ascender



The LED on the Ascender will turn blue to indicate control has been taken over by the Remote Control.

3. Operate the Ascender

Confirm that the remote connection is established by moving the ICX with the remote control thumb wheel in the desired direction. The initial operation should be performed at the minimum speed before proceeding with the lifting operation.

4. De-activation



Switch off the remote control. The Remote control will switch itself off after 30 min of its last use.

 **CAUTION**

The Remote Control will only work with the Ascender it has been delivered with. The serial number of the assigned Ascender is indicated on the Remote Control. In case of using multiple Ascenders, mark your Remote Controls to avoid any confusion.

When using the remote control, make sure a distance of at least 20 cm (8") is kept between the remote control and your torso and/or head.

 **Note**

Remote Control does not work if Emergency Stop is pressed or if the Ascender is switched off. Once the Ascender is switched back on again the Ascender can be used manually. The remote connection needs to be re-established by turning the Remote Control off and on again.

 **CAUTION**

Visual contact with ascender is required during remote control operation.

To prevent unauthorized use, the remote control shall not be left unattended.

Remote Control Battery



The Remote Control unit is equipped with an internal battery which is charged via USB cable. Complete charging will take up to 150 minutes via a computer, or 75 minutes with a high performance adaptor. The USB Connection Point can be found on the top of the Remote Control under the protection cap.



The battery LED on the Remote Control will flash at 10% charge. The power LED will flash green during charging and will turn off once charging is completed.



CAUTION

Make sure that the Remote Control has visual contact with the Ascender to ensure safe operation and maximum range.

When using the Remote Control, should the unloaded rope be held by an operator to ensure that the rope can run unhindered into the Ascender while lowering. Uncontrolled rope running into the Ascender can cause a rope jam and eventually rope damage.



RECOMMENDATION

Always use the Remote Control in combination with a stop knot at the end of the rope.

F.09 TRANSPORTATION

Carry the Ascender by the lifting handle for short walking distances.

When carrying the Ascender any further stow it in the transportation box as this will protect the Ascender from any damage. Make sure the Ascender is secured when travelling in any vehicle.

F.10 STORAGE

Always clean and dry the Ascender and the transportation box before storage. See section G for cleaning instructions.

Always store the Ascender, Batteries and the Remote Control dry at a temperature between 5°C (41°F) and 25°C (77°F). For more detailed Battery storage information, see section E.09.

Note

The Ascender Batteries hold over 100 Wh of power and are therefore fully regulated as Dangerous Goods (*Class 9 UN3480* Lithium Ion Batteries) and must be handled and shipped accordingly. Contact your SKYLOTEC distributor or SKYLOTEC directly for further details.

CAUTION

Always store the Battery fully charged.

The Battery can stay connected to ICX during transport or short term storage (1 week). For longer storage, store the Battery disconnected and perform a maintenance charge every 3 months.

F.11 CHECKLIST BEFORE USE

Always check the Ascender before every use. Check the Ascender thoroughly and in accordance with your training and this manual.

If you are in any doubt about the condition of the Ascender, do not use it and contact your SKYLOTEC supplier or SKYLOTEC directly.

✓ **Inspection of ICX / Husqvarna Battery Pack**

- » No damage to Battery Housing
- » Connector pins clean and not damaged
- » Battery charged

✓ **Inspection of ICX Ascender**

- » Check the Ascender housing for cracks or severe damage
- » Check the Battery Connector pins on the Ascender:
 - Clean and no damage
- » Slide the Battery into the Ascender and check that the Battery is locked in its position

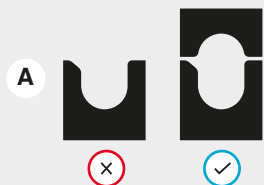

✓ **Visual inspection of load-bearing parts**

» **Rope Guide (A)**

Check Rope Guide for obvious damage, deformation or sharp edges. Rope Guide should not be bent and must fit neatly with the Rope Cover.

» **Rope Cover**

Check the Rope Cover function by opening and closing it. During closing the Rope Cover must lock unhindered into its position. Check the Rope Cover further for deformation, excessive wear or any sharp edges

» **Rope Wedge (B)**

Check Rope Wedge for deformation or any visible damage. The Rope Wedge should be straight, sit just above the bottom of the Rope Grab and should not touch the ribs on the inside of the Rope Grab

» **Rope Grab (C)**

Check that Rope Grab is clean and not filled with dirt, sand, paint or any other foreign material. Check the inside for obvious damage, signs of wear or sharp edges

» **Connection Sling and Carabiner (D)**

Check Connection Sling for wear, discoloration or damage such as cuts, abrasion and contaminants (paint, glues, chemicals). Take particular note of the condition of the Titanium Sling Bolt and Carabiner Loop. Inspect the carabiner for wear, damage and deformation. Check that the Carabiner opens and locks correctly

✓ **Controls check**

- » Check that the Emergency Stop is pulled out and switch Ascender on. Wait for full activation of the Ascender (LED turns green)
- » Move the Throttle in both directions and ensure that Rope Grab turns smoothly in both directions
- » Check that the emergency descent is working correctly.
- » Push the Emergency Stop and check that the Ascender is switched off and cannot be activated by Power Button

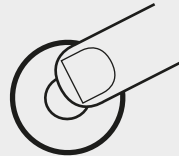

For a full inspection checklist contact
info@skylotec.se

G

SERVICE & MAINTENANCE

Maintenance and cleaning
of the Ascender

G.01

Troubleshooting guide

G.02

G

Only use original spare parts and materials recommended and supplied by SKYLOTEC.

Basic Inspection Guidance for users and third party inspection:

To be used safely, each Ascender should meet following requirements at all times:

- » No obvious damage or excessive wear on Ascender and its components
- » Basic function test of Ascender including Emergency Stop and emergency descent (see section F.10)
- » 1,25 x SWL dynamic load test; descending full speed and then stop with max 10 cm (3,9") slippage
- » 1,5 x SWL static load test; no slippage allowed

i RECOMMENDATION

Go through 'Checklist before use' (F.11) during every maintenance.

G.01 MAINTENANCE & CLEANING OF THE ASCENDER

Repairs, annual service and inspection shall be carried out by an SKYLOTEC-authorized service partner. More frequent inspection intervals may be required because of local regulations.

Cleaning the Ascender

- ✓ Wipe the Ascender with a wet cloth and let it dry. Do not clean the Ascender with a high-pressure cleaner
- ✓ Clean the Carabiner thoroughly, lubricate with thin oil and wipe dry
- ✓ Spray the pins with an electronic connector cleaner/lubricator when needed

✓ Note

DO NOT use a high-pressure cleaner.

G.02 TROUBLESHOOTING GUIDE

If you need further assistance or are in any doubt please contact SKYLOTEC or your approved SKYLOTEC distributor.

PROBLEM	PROBABLE CAUSE	REMEDY
Battery does not work	Battery is flat BMS shut Battery off because of battery damage or worn out Battery Battery is too cold — below -10°C (14°F) Battery is too hot — above 55°C (131°F)	Charge the Battery Exchange Battery Let the Battery warm up Let the Battery cool down
Battery does not charge	Charger not connected Charger broken Battery is too warm Battery is too cold — below -10°C (14°F) Battery is worn out	Connect Charger to socket Change Charger Let the Battery cool down Let the Battery warm up Replace the Battery
Emergency Descent does not work	Descent Button disconnected	Contact Skylotec or speak with your dealer

PROBLEM	PROBABLE CAUSE	REMEDY
No power	Battery is too warm — red LED blinks on Battery Battery is too cold — below -10°C (14°F) Battery not charged Too short a press on Power Button Emergency Stop engaged	Let the Battery cool down Let the Battery warm up Check Battery, charge when empty Press for 2 seconds Disengage Emergency Stop
Warning LED turns red	Emergency Stop engaged Ascender is overheated Problem with Battery Error detected in Ascender The Rope Cover is not Closed	Disengage Emergency Stop Let Ascender cool down Try another Battery Restart: LED Green — OK LED Red — Contact SKYLOTEC distributor or SKYLOTEC Close the rope Cover
Remote control does not connect	Ascender is not switched on Distance too far Signal interference Remote Control from another Ascender	Switch Ascender on Get closer to Ascender Get closer to Ascender Find correct Remote Control

PROBLEM	PROBABLE CAUSE	REMEDY
Remote control does not work	Remote Control Battery is empty	Charge Remote Control
Rope Cover does not lock	Dirt in Rope Cover Dirt in locking mechanism Mechanical damage	Clean Rope Cover Clean and oil locking mechanism Contact SKYLOTEC distributor or SKYLOTEC
Rope slippage in Rope Grab	Rope is too soft Wrong rope diameter Rope is not pre-soaked (only polyamide ropes) Worn out rope grab	Use recommended rope/pre-test rope Use recommended rope/pre-test rope Soak rope Contact SKYLOTEC distributor or SKYLOTEC
No Response to Throttle	No power on Ascender Remote control is operating Ascender — blue power LED Too much load on the Ascender Battery not working The Rope Cover is not Closed	See 'no power' section of trouble-shooting guide Restart Ascender or wait for Remote to turn off Reduce the load to SWL or less See Battery section of troubleshooting guide Close the rope Cover

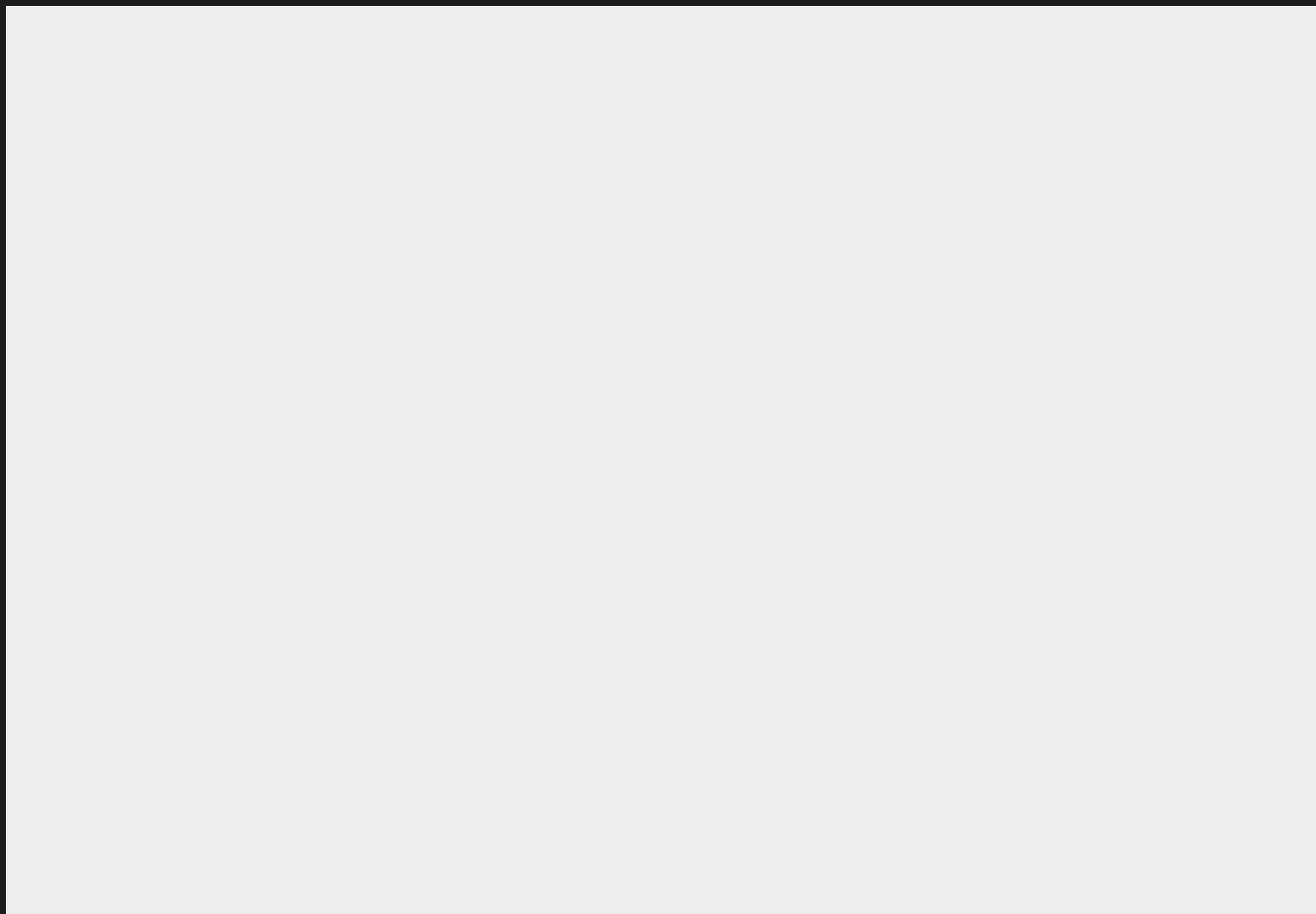



POWER ASCENDERS WARRANTY TERMS

Warranty terms

H.01

H.01 WARRANTY TERMS

SKYLOTEC Nordic AB ("SKYLOTEC") guarantees that the ACX Power Ascender ("Product") purchased has no defects in material and workmanship. This is subject to the terms of the limited warranty ("Warranty") given below.

Any claim must be made within the warranty period which is one year from delivery unless otherwise agreed.

SKYLOTEC will, through repair or replacement as appropriate in SKYLOTEC's reasonable discretion, remedy any defect that is covered by the limited warranty and notified in writing within the warranty period. SKYLOTEC reserves the right to use reconditioned parts with performance parameters equal to those of new parts in any repair performed under the Warranty.

Claim under SKYLOTEC's warranty

Claims under SKYLOTEC's Warranty may be made only by direct customers of SKYLOTEC who, upon SKYLOTEC's request, can present the original sales invoice from SKYLOTEC.

The Warranty is not transferable from one user or customer to another.

If you have purchased your product from an authorized distributor of SKYLOTEC products, please contact the distributor for warranty claims.

Warranty Limitations

The warranty does not extend to:

- (i) Products which have been modified, repaired or reconditioned by a party not authorised by the Seller;
- (ii) defects or damage resulting from failure to maintain or operate the Products in accordance with the Seller's recommendations;
- (iii) normal wear and tear;
- (iv) damages which are the result of abuse or negligence including but not limited to water intrusion, physical damage; electrical faults external to the Products, rust or corrosion;
- (v) Products for which the serial number has been removed or tampered with; and

(vi) Products to which a component or product not authorised by the Seller has been added. Repair and replacement in accordance with the warranty terms are the sole and exclusive remedies for defects. The Warranty is exclusive and no other warranties, whether statutory or implied shall apply to the Products, including but not limited to warranties of merchantability or fitness for a particular purpose. Any implied warranty that may be imposed by applicable law is limited to the warranty period.

Except as otherwise required by governing law, under no circumstances (including negligence) shall SKYLOTEC, its affiliates, and their respective directors, officers,

employees or agents be liable for any consequential, incidental, indirect, punitive, special or other similar damages, whether in action of contract, negligence or other tortious action, arising out of, in connection with or resulting from the sale or provision of any Products.





TECHNICAL DATA

Technical data

1.01

PERFORMANCE/PART	VALUE	COMMENT
Rope	Personnel Lifting – Approved ropes 11 mm, Equipment Lifting — SKYLOTEC ELR	See our website for approved ropes. Polyamid ropes should be soaked before first use. See section C.01
Safe Working Load (SWL /WLL)	185 kg (407 lb)	
Ascent speed	0-24 m/min (0-78 ft/min)	
Descent speed	0-24 m/min (0-78 ft/min)	
Emergency descent speed	0-24 m/min (0-78 ft/min)	
Battery range (with Husqvarna BLi200)	Approximately 230 m at 100kg (754 ft at 220 lb)	At 20°C (68°F), continuous ascending. See section E.02
Charging time	80 min	Charging time for an empty Battery
Temperature range	-10°C (14°F) to 40°C (104°F)	Values apply to ambient temperature. See E.02 for more info
Over heating protection	Yes	
Ascender weight	6.8 kg (15 lb)	Ascender weight with BLi200 battery is 8,1 kg (17,9 lb)
Battery weight	BLi200: 1,3 kg (2,9 lb) BLi300: 1,9 kg (4,2 lb)	
Dimensions	24,9 x 21,7 x 25,5 cm (9,8 x 8,5 x 10,0")	
Remote Control	Range – up to 50m (164 ft) Radio frequency – 2.4 GHz	The remote must have visual contact with the Ascender to ensure maximum safety and range
Water/dust resistance	IP 55	
Noise level	76 dB	
Max windspeed	12 m/s (39 ft/s)	Weather conditions should be stable and favourable to not affect the safety of personnel and/or lifting operation
Vibration level		

LOGBOOK

Initial delivery	A
Inspection	B
Replaced consumables	C
Usage log	D

A. INITIAL DELIVERY

SKYLOTEC Nordic AB

Phone: +46 31 655 660

Email: info@skylotec.se

Serial number of Ascender

Year of manufacture

Delivery date

Approval for use

Stamp and Sign

Signature

B. INSPECTION

Date	Stamp and sign
Approved for use Yes <input type="checkbox"/> No <input type="checkbox"/>	
Name of Inspector	

Date	Stamp and sign
Approved for use Yes <input type="checkbox"/> No <input type="checkbox"/>	
Name of Inspector	

Date	Stamp and sign
Approved for use Yes <input type="checkbox"/> No <input type="checkbox"/>	
Name of Inspector	

Date	Stamp and sign
Approved for use Yes <input type="checkbox"/> No <input type="checkbox"/>	
Name of Inspector	

Date	Stamp and sign
Approved for use Yes <input type="checkbox"/> No <input type="checkbox"/>	
Name of Inspector	

Date	Stamp and sign
Approved for use Yes <input type="checkbox"/> No <input type="checkbox"/>	
Name of Inspector	

B. INSPECTION

Date	Stamp and sign
Approved for use Yes <input type="checkbox"/> No <input type="checkbox"/>	
Name of Inspector	

Date	Stamp and sign
Approved for use Yes <input type="checkbox"/> No <input type="checkbox"/>	
Name of Inspector	

Date	Stamp and sign
Approved for use Yes <input type="checkbox"/> No <input type="checkbox"/>	
Name of Inspector	

Date	Stamp and sign
Approved for use Yes <input type="checkbox"/> No <input type="checkbox"/>	
Name of Inspector	

Date	Stamp and sign
Approved for use Yes <input type="checkbox"/> No <input type="checkbox"/>	
Name of Inspector	

Date	Stamp and sign
Approved for use Yes <input type="checkbox"/> No <input type="checkbox"/>	
Name of Inspector	

C. REPLACED CONSUMABLES

Date	<input type="checkbox"/> Rope Grab <input type="checkbox"/> Rope Guide <input type="checkbox"/> Rope Wedge <input type="checkbox"/> Rope Cover	<input type="checkbox"/> Connection Sling <input type="checkbox"/> Lifting Handle <input type="checkbox"/> Carabiners <input type="checkbox"/> Other(see protocol)	Stamp and Sign
Date	<input type="checkbox"/> Rope Grab <input type="checkbox"/> Rope Guide <input type="checkbox"/> Rope Wedge <input type="checkbox"/> Rope Cover	<input type="checkbox"/> Connection Sling <input type="checkbox"/> Lifting Handle <input type="checkbox"/> Carabiners <input type="checkbox"/> Other(see protocol)	Stamp and Sign
Date	<input type="checkbox"/> Rope Grab <input type="checkbox"/> Rope Guide <input type="checkbox"/> Rope Wedge <input type="checkbox"/> Rope Cover	<input type="checkbox"/> Connection Sling <input type="checkbox"/> Lifting Handle <input type="checkbox"/> Carabiners <input type="checkbox"/> Other(see protocol)	Stamp and Sign

C. REPLACED CONSUMABLES

Date	<input type="checkbox"/> Rope Grab <input type="checkbox"/> Rope Guide <input type="checkbox"/> Rope Wedge <input type="checkbox"/> Rope Cover	<input type="checkbox"/> Connection Slings <input type="checkbox"/> Lifting Handle <input type="checkbox"/> Carabiners <input type="checkbox"/> Other(see protocol)	Stamp and Sign
Date	<input type="checkbox"/> Rope Grab <input type="checkbox"/> Rope Guide <input type="checkbox"/> Rope Wedge <input type="checkbox"/> Rope Cover	<input type="checkbox"/> Connection Slings <input type="checkbox"/> Lifting Handle <input type="checkbox"/> Carabiners <input type="checkbox"/> Other(see protocol)	Stamp and Sign
Date	<input type="checkbox"/> Rope Grab <input type="checkbox"/> Rope Guide <input type="checkbox"/> Rope Wedge <input type="checkbox"/> Rope Cover	<input type="checkbox"/> Connection Slings <input type="checkbox"/> Lifting Handle <input type="checkbox"/> Carabiners <input type="checkbox"/> Other(see protocol)	Stamp and Sign

SKYLOTEC Nordic AB
Sagbäcksvägen 13
SE-43731 Lindome, Sweden

T: +46 31 65 56 60
E: info@skylotec.se
W: www.skylotec.com

© 2023 SKYLOTEC Nordic AB

